

#### Step 4

Fit remaining support pole as shown in previous steps.

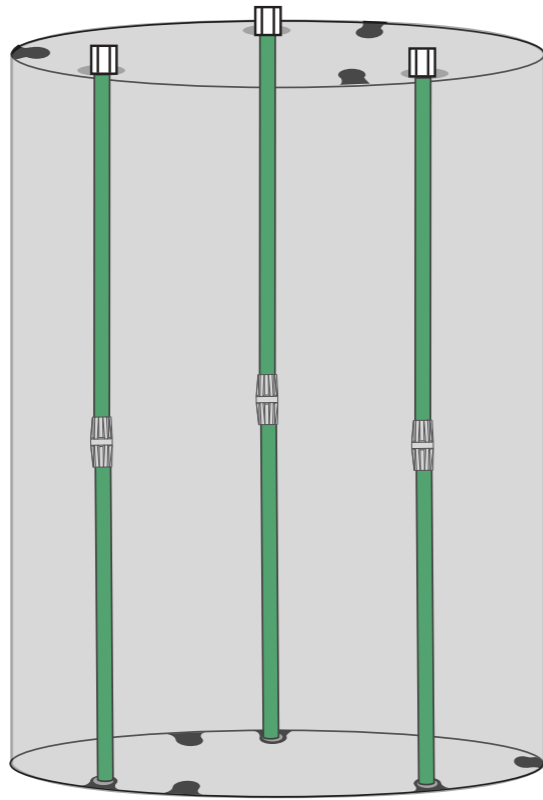

## Assembly Instructions



### COLLAPSIBLE RESERVOIR

- Ultra strong, anti-tip design
- Simple assembly in minutes
- Reflective and light tight
- Internal capacity markings
- All fittings included
- 1 year manufacturers warranty

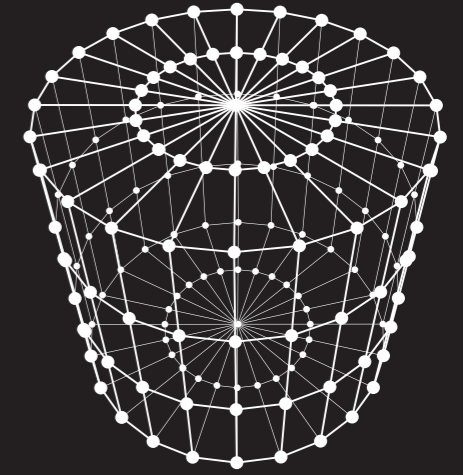

Dimensions when full:

**100ltr/25gal**

465mm x 700mm / 18" x 27.5"

#### Step 5

- Ensure tap is in the closed position →

Position your FlexiTankPro on a smooth flat surface. Half fill with water.

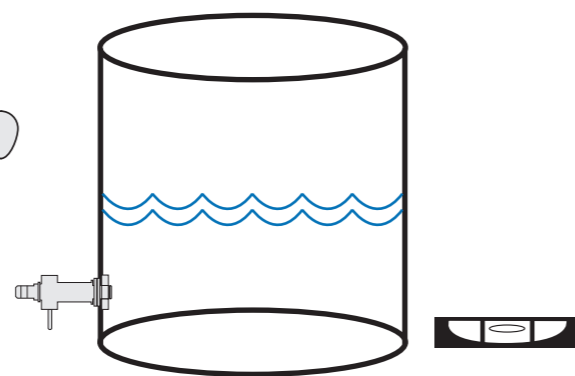

Twist the tap clockwise to the upright position. Top up water to required amount.

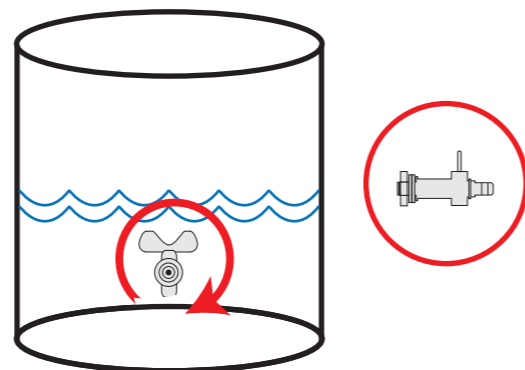

### Parts List

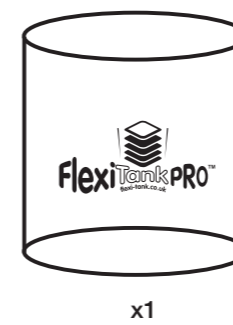

x1



Pole  
x6



Pole  
Connector  
x3

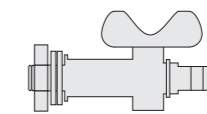

Outlet Tap x1  
(inc x2 washer, x1 locking nut)

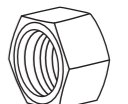

Pole Locking  
Nut x3

#### Safety

Never drag or move the FlexiTankPro when Full of water. The FlexiTankPro should be completely drained before it is moved.

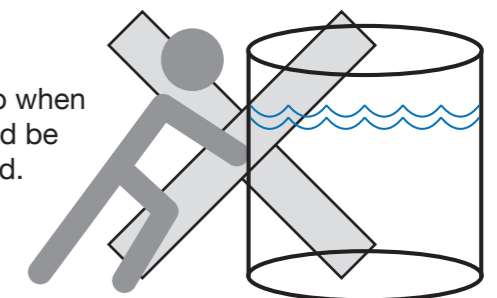

### Step 1

**Fitting Outlet Tap:**  
Push outlet tap through the FlexiTankPro, fitting the rubber washers as shown (A). Fit the tap upside down tightening as tight as you can by hand.

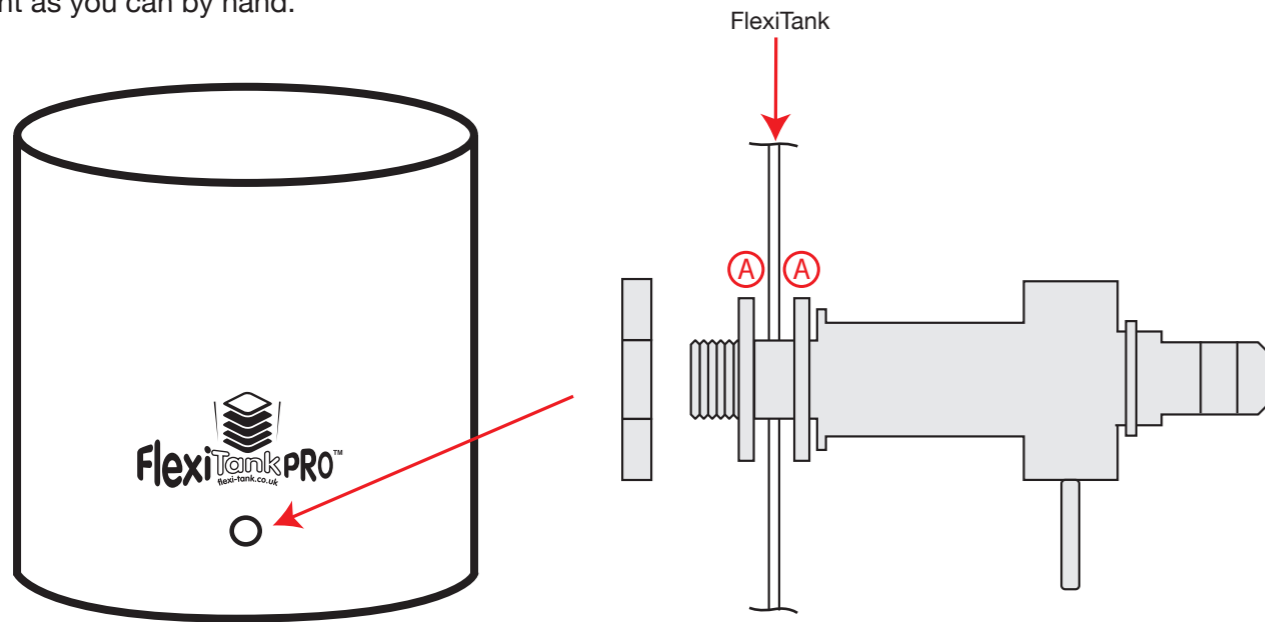

### Step 3

**Fitting First Support Pole:**

Accessing tank through top zipper.

- 1 Remove pole locking nuts from outside top.
- 2 Push lower part of support pole into bottom location feature and straighten.
- 3 Slot upper support pole through hole in upper ring.

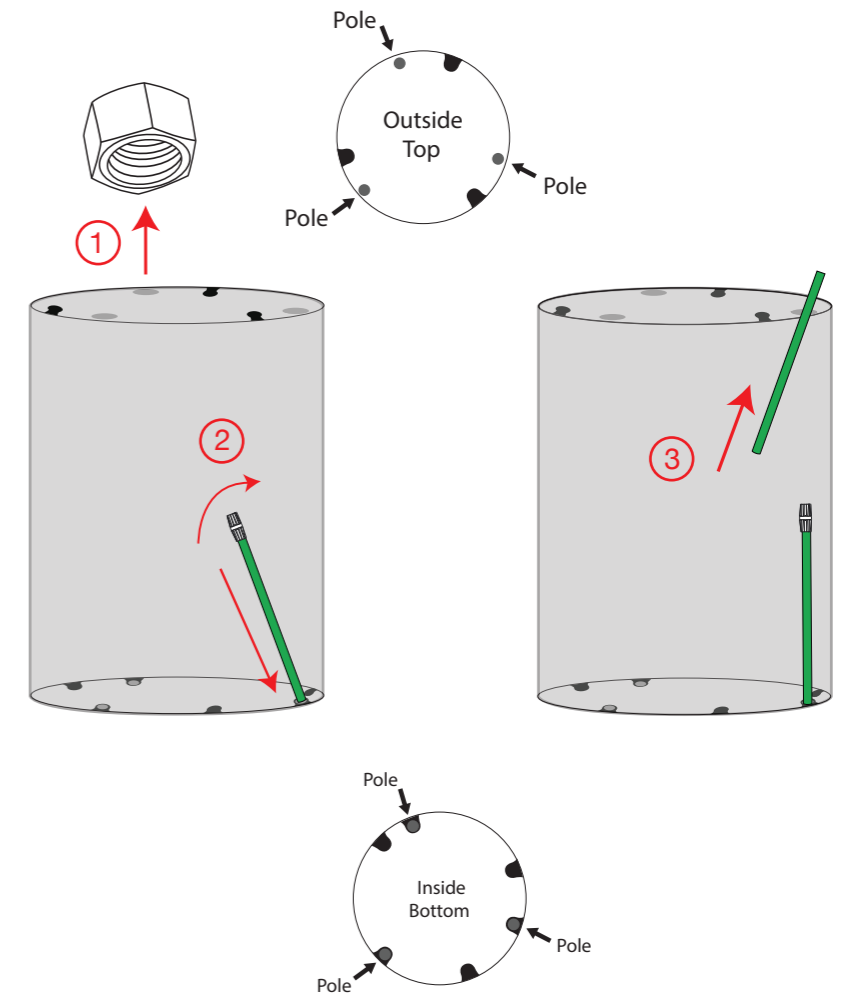

### Step 2

Fit connector to three of the support poles. Ensure pole is fully inserted into connector by exerting pressure from above.

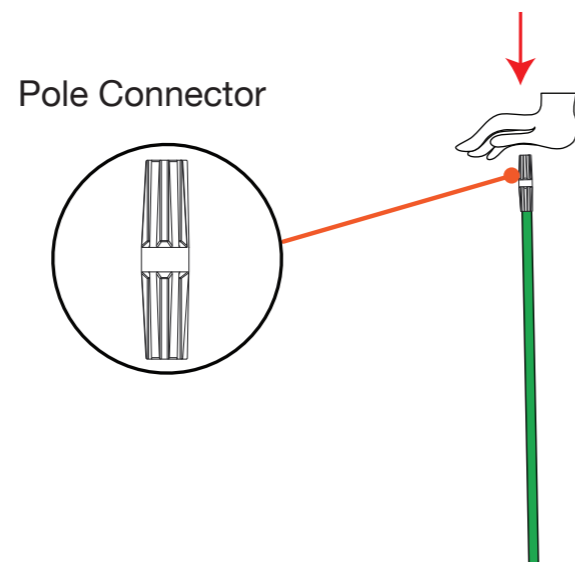

**Fitting Support Pole Continued:**

- 4 Straighten top support pole and fit into connector. Ensure pole is fully inserted into connector by exerting pressure from above.
- 5 While applying pressure to the underside of top ring, screw on pole locking nut.

